

INFLUENCE OF TOOL GEOMETRY ON THE PROCESS OF TURNING Ti-6Al-4V

Jindrich Sykora & Simon Syrovatka

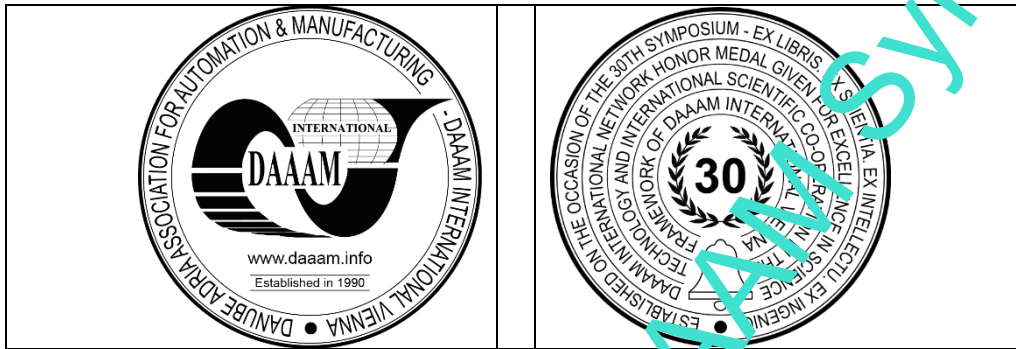

This Publication has to be referred as: Sykora, J[indrich] & Syrovatka, S[imon] (2022). Influence of tool geometry on the process of turning Ti-6Al-4V, Proceedings of the 33rd DAAAM International Symposium, pp.xxxx-xxxx, B. Katalinic (Ed.), Published by DAAAM International, ISBN 978-3-902734-xx-x, ISSN 1726-9679, Vienna, Austria
DOI: 10.2507/33rd.daaam.proceedings.xxx

Abstract

Titanium alloys are widely used in the aerospace and medical industry and these industries generally require parts of high precision and good surface finish. The ratio between Young's modulus of elasticity and the ultimate tensile strength of titanium alloys is approximately half in comparison with C45QT steel. This manifests itself in the lower resistance of titanium workpieces against deformation induced by cutting forces. It can be especially detrimental when workpieces of a high length-to-diameter ratio are turned. This work is focused on the analysis of the process of turning Ti-6Al-4V under various cutting conditions when machining cylindrical and conical geometry. Cutting forces were measured and evaluated to find requirements for minimizing the F_p component of the total cutting force. This will result in a decrease in workpiece deformation and therefore vibration and an increase in the surface quality and dimensional accuracy. Positive inserts of ISO C and D shapes with 0,2 mm nose radius are evaluated and the depth of cut is varied.

Keywords: turning; cutting forces; depth of cut; Ti-6Al-4V

1. Introduction

Titanium as a pure metal is characterized by its corrosion resistance, high tensile strength and high biocompatibility. This type of metal is often used for the production of alloys, with which its very good properties are further enhanced. The most widely used titanium alloy is Ti-6Al-4V. This alloy is widely used, for example, in the aviation and space industry or in medicine [1]. However, high-speed machining of this alloy is very problematic precisely because of its excellent mechanical properties, which include low modulus of elasticity or low thermal conductivity. Poor machinability of this alloy can lead to surface defects or poor surface integrity, which can affect the service life of components made from this alloy. Regarding to the turning process, the final surface quality is influenced by several factors, including the macro and micro geometry of the tool, the cutting parameters of the manufacturing process or the type of cooling medium [2].

During the machining method of turning, three basic working parameters are used to influence the process. These parameters are cutting speed (v_c), feed (f) and depth of cut (A_p).

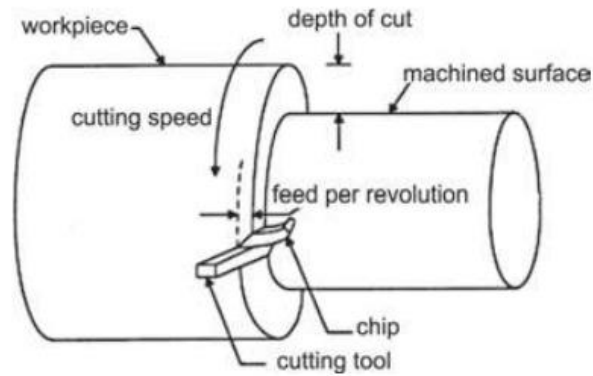

Fig. 1: Scheme of turning process [3]

Determining the correctness of the operating parameters can be done in several ways. These include, for example, measuring the surface roughness of the final surface, measuring cutting tool wear, the efficiency of the machining process or measuring the magnitude of the cutting forces generated.

The main cutting force F in the turning process consists of three forces, namely the cutting force F_c which is usually the largest, then the feed force F_f and the passive force F_p which is perpendicular to the machined surface [4].

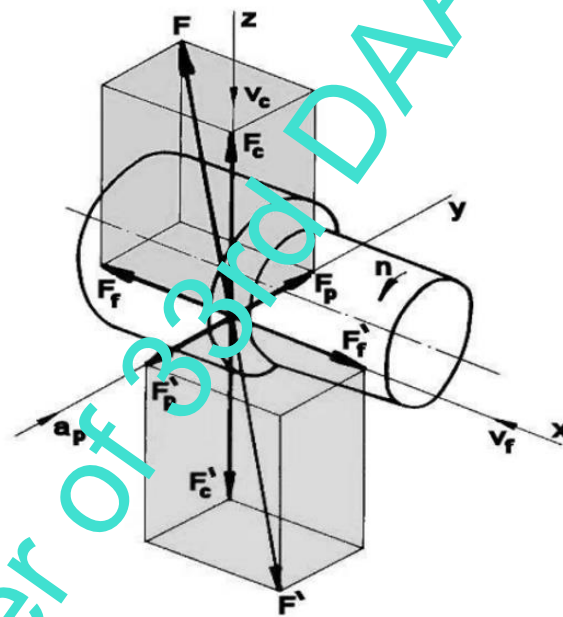

Fig. 2: Cutting forces [5]

The main cutting force F can be calculated using the following equation

$$F = \sqrt{F_c^2 + F_f^2 + F_p^2} \quad (1)$$

In the case that the correctness of working parameters is decided based on the size of the main cutting force F it can be said that smaller values of the main cutting force F indicate the choice of more suitable working parameters. For to measure the cutting forces generated during the turning process three-component dynamometers are very often used [6]. These devices can be divided according to the method of measuring (mechanical, hydraulic, pneumatic, electrical (piezoelectric), optical) [7].

The magnitude and the cutting force ratio are primarily influenced by the tool's geometry, cutting parameters and the workpiece material. Although things like tool wear, the material of the tool and the surface finish of the tool can also play a major role. This work is focused on the influence of the side cutting edge angle (SCEA) and end cutting edge angle

(ECEA). The importance of the side cutting edge angle was shown by Saglam. In this work, AISI 1040 steel was turned and the cutting forces were measured at varying side cutting edge angles (45° , 60° , 75° , 90°) and rake face angles of 0° , 6° and 12° . Fig. 3 clearly shows the significant influence of the side cutting edge angle (entering angle). Feed force increases with the growth of SCEA while the thrust force decreases [8]. Thrust force and main cutting force (F_c) in combination contribute to workpiece deformations during the turning process. This can lead to dimensional and geometrical inaccuracies, and it is, therefore, advantageous to minimize these two components of the main cutting force. As stated above, this can be achieved through changes in geometry and SCEA plays a significant role. One of the ways the main cutting force can be lowered is by decreasing an uncut chip cross section area (UCCA). This can be achieved by reducing the feed rate and depth of cut. This work is focused on the influence of depth of cut, which should always be related to nose radius. Manufacturers generally advise not to use the deep of cut (DOC) lower than $2/3$ of the nose radius. The main reason is that with low DOC nose radius changes the effective SCEA angle and makes it lower. Consequently, the ratio of the thrust force increases leading to undesirable deformations during the machining process. The main cutting force is also largely influenced by the tool rake angle and edge radius. With an increase in the rake face angle, the main cutting force lowers. The same is true for a decrease in the edge radius [9]. However, these two parameters also reduce the edge stability, and their modification can lead to rapid tool wear. In this work highly positive inserts are used, for this reason, other methods, such as reduction in DOC are investigated.

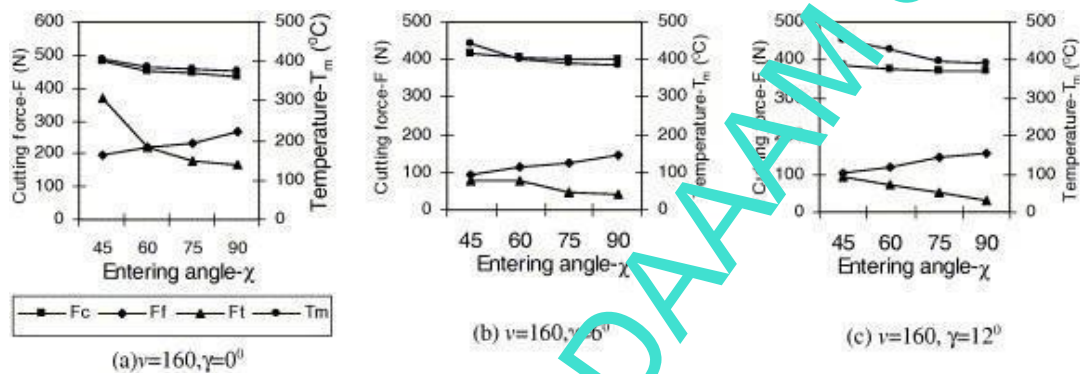

Fig. 3. Influence of SCEA on the cutting forces

One of the unique characteristics of titanium alloys is the ratio between tensile strength and modulus of elasticity. This ratio is approximately double in comparison to C45 steel (see Table 1) [10], [11]. This fact must be considered for machining setups. This also is the reason why turning slender workpieces from titanium alloys can be especially challenging. The low modulus of elasticity causes the part to deflect much more severely due to the cutting forces. In this case, the role of F_p is especially important. Deformation of the workpiece caused by this force component causes geometrical and dimensional inaccuracies of the part. Furthermore, the stability of the process may be decreased and lead to vibrations and compromised surface finish [12]. This study, therefore, investigates how various conditions influence the cutting forces and how these results can be used when turning Ti6Al4V parts on non-swiss type lathes.

Material	R_m [MPa]	E [GPa]	Thermal conductivity [W/m.K]
Ti6Al4V – Grade 5 (annealed)	950	113.8	6.5-7.5
ISO C45QT	630-780	210	40-45
ISO 7075-T6	572	71.7	130

Table 1. Comparison of mechanical properties largely influences the machinability [10], [11], [13]

2. Materials and methods

Cylindrical workpieces of Ti6Al4V Grade 5 alloy were used with an initial diameter of 30 mm. The cutting tests were performed using Emco Maxxturn 25 with 6.5 kW and 8000 RPM spindle. There were two types of tools used in the experiment, both manufactured by Iscar. Firstly, it was the SCLCL 1212F-09 insert holder with CCGT 09T302 – AS IC520 inserts which provide the side cutting edge angle of 95° and ECEA of 5° . These inserts have highly positive geometry with an $8 \mu\text{m}$ cutting edge radius and rake angle of 20° and are PVD coated with a combination of TiCN and TiN. Secondly, the SDJCL 1212F-11 insert holder was used with an SCEA of 93° and an ECEA of 32° . The used insert was DCGT 1212F-11T302 – AS IC320, it is again a highly positive insert with a cutting edge radius of $6 \mu\text{m}$ and a rake angle of 20° . Most of the geometrical parameters of both these tools are very similar and the only significant difference is ECEA.

The cutting forces were measured using a Kistler MiniDyn Multi-component dynamometer. To make the results of these tests relevant for industrial purposes and minimize tool wear, an external coolant line was used to deliver the coolant medium to the cutting edge.

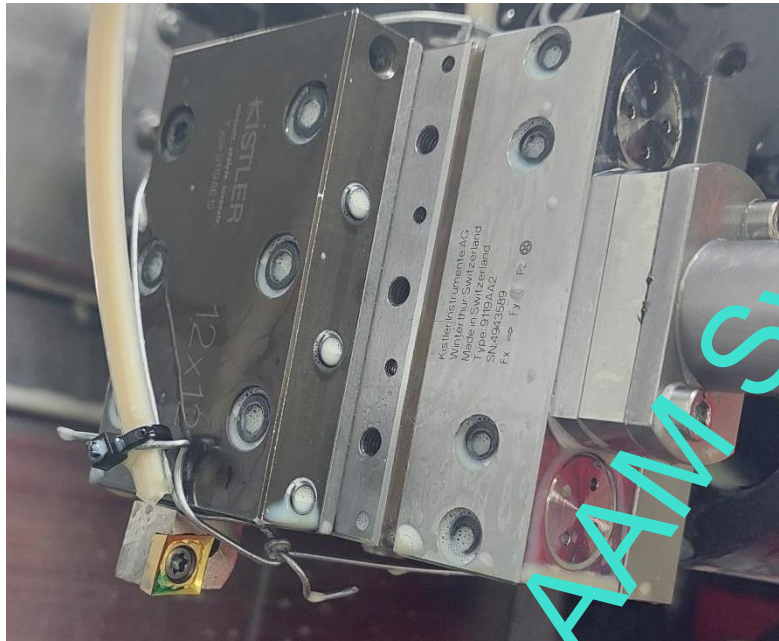

Fig. 4. Tool and dynamometer set up in the machine tool

3. Experimental setup

The experiment was designed to compare the influence of tool geometry (ECEA), workpiece geometry and depth of cut on the cutting forces. Therefore, the rest of the parameters were kept constant. The cutting speed was fixed at 60 m/min which is usually at the bottom of the cutting speed range recommended by tool manufacturers for this material and carbide inserts. This somewhat low cutting speed was used to minimise the influence of tool wear on the results of the experiment. Because this study aims to explore conditions for finishing operation, the feed rate was set to 0.1 mm/rev. It is a value in the middle of the range recommended by the tool manufacturer for this nose radius and should be suitable for general finishing operations.

There were two workpiece geometries machined, a cylindrical section with a constant length of 30 mm and a taper with an included angle of 30° and an initial length of 17.5 mm. The cutting time decreased with each successive pass for the cylindrical specimen and increased for the tapered specimen, however, it should not severely influence the cutting forces. The tool wear VB was measured for the CC insert after the first 4 min in cut and at the end of the cutting trials. The difference is 8 μm , therefore, its influence on the measured data is not very significant and was not evaluated. The DOC was varied on four levels, it was 0.5, 0.3, 0.2 and 0.1 mm. This way the relationship between the nose radius to DOC ratio and cutting forces could be evaluated. The goal of this paper is to provide data that can be applied to the machining of titanium workpieces of high length to diameter ratios.

One of the main concerns in these situations is the deformation induced by cutting forces. The most significant role is played by the F_p and F_c forces. When a cylindrical part is turned the F_p force corresponds to the direction of an X axis of a lathe and the F_c force corresponds with the direction of a Y axis. However, for a tapered workpiece, the direction of the F_p would be at an angle corresponding with the taper. Although, for this study forces in the directions of the machine coordinate system were evaluated. This approach allows for better comparison between the workpiece geometries.

The uncut chip cross section area is one of the main factors that influence the magnitude of the cutting force. For the cylindrical workpiece and DOC of 0.5 mm with SCLCL insert is the value of this parameter 0.0498 mm^2 the difference in this factor between the insert types and workpiece geometries is within 0.05 %, therefore, it is extremely small and is not considered in the evaluation.



Fig. 5. Workpiece geometries

4. Results and discussion

In total 16 individual tests were performed. As predicted, the main cutting force decreases with the reduction of DOC. The uncut chip cross section area certainly plays a major role and a reduction in this value will play a major role in total cutting forces. Fig. 5 compares the main cutting forces, the CCGT insert generated a significantly higher main cutting force when DOC 0.5 and 0.3 mm were used. An even higher difference can be observed in figure X where F_x forces are compared. These two results are exceptions in the data set and point toward an unknown variable in the process. For this reason, the hardness of the material was measured on the original surface and a diameter of 17 mm. The original surface shows a hardness of 393 HB whereas the middle of the specimen shows only a hardness of 105 HB. This demonstrates a significantly higher value of ultimate tensile strength on the surface which would lead to significantly higher cutting forces. As the test with 0.5 mm and 0.3 mm DOC were performed as the first ones, they were probably influenced by the described mechanical properties of the specimen. Towards the end of a cut (near the surface), forces are much higher. Unfortunately, this fact was realised during the evaluation phase and the first two trials could not be repeated, for this reason, the results are excluded from further evaluation.

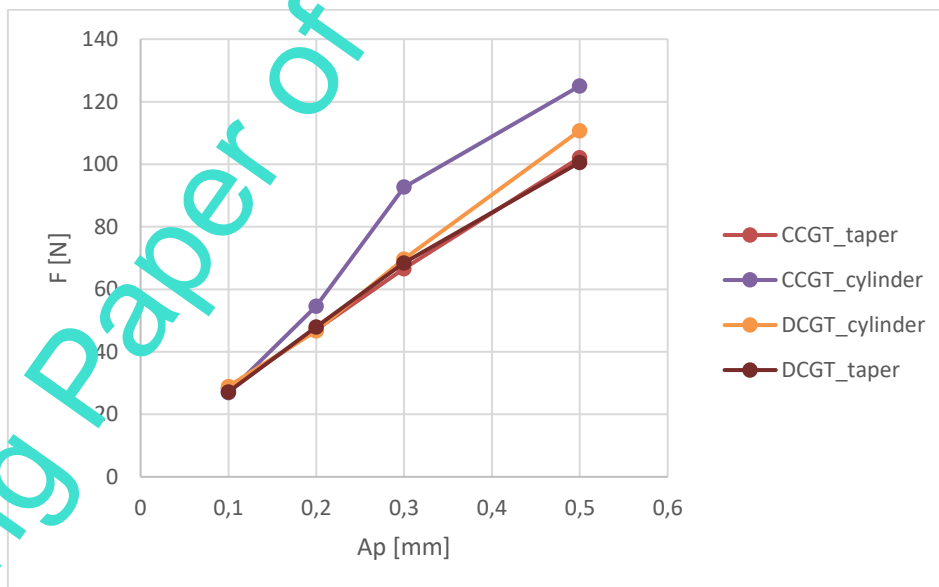

Fig. 6. Dependence between DOC and main cutting force

The first of the evaluated variables is the workpiece geometry. The direction of an F_p and F_f forces obviously changes with the specimen geometry. However, this study is concerned with force directions F_x and F_z which match the machine coordinate system. The main cutting force varies by less than 15 % and there is not a significant difference between tapered and cylindrical geometry. Nonetheless, figures 8 and 10 show a clear difference in F_x and F_z forces where F_x forces are reduced when the taper is machined, and the opposite is true for F_z forces. In the case of the cylindrical geometry, the cutting force F_x is on average 21 % of the main cutting force but when tapered geometry is machined it is only 15 % of the main cutting force. The F_p and F_f forces are very similar for both machined geometries, yet the F_x force which induces significant deformations in the workpiece is lower when the taper is machined.

The tool geometry was a second evaluated factor and the main differences between the tools were SCEA and ECEA. The results show that higher F_x force is generated when CCGT inserts are used for both cylinder and taper. For a tapered workpiece, the F_x force is on average only 4 % higher for the CCGT insert. In terms of a cylindrical workpiece, the difference is 17 %. This result confirms the benefit of higher ECEA when the F_x force needs to be reduced. The tapered workpiece geometry essentially increases the effective ECEA making it 20° for the CCGT insert. Therefore, the difference between the inserts is less noticeable in this case.

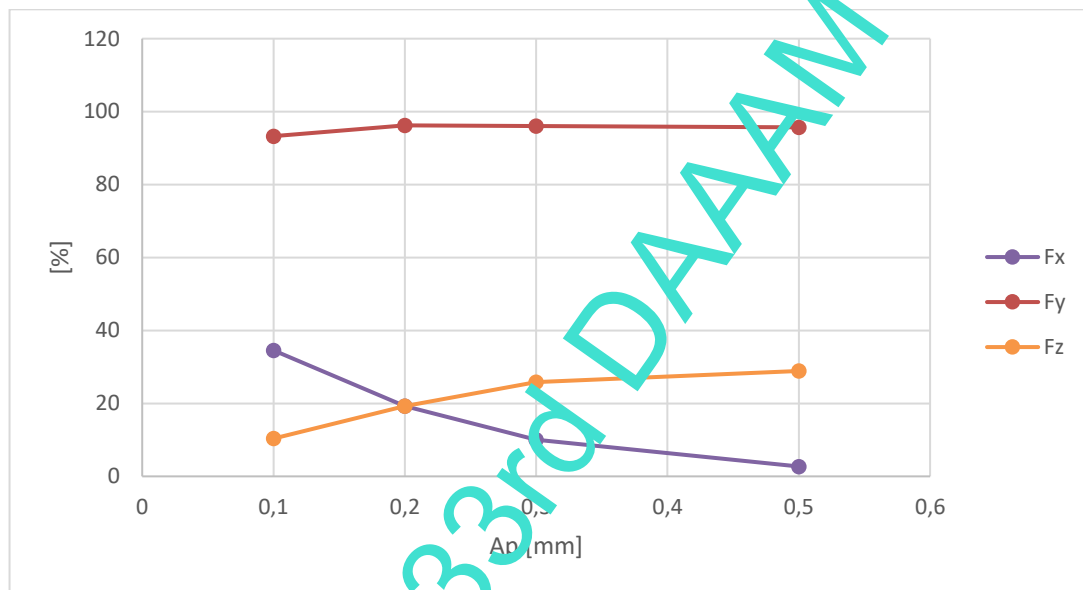

Fig. 7. The influence of DOC on the ratio of force components and main cutting force – turning cylinder with DCGT insert

Lastly, the influence of DOC was investigated. It is generally advised to use DOC values higher than $2/3$ of the nose radius. Lower values may lead to vibrations and inferior chip breaking. One of the reasons for this recommendation is the growth of the F_x cutting force. The results clearly show the exponential growth of this force component with a decrease in DOC. As can be seen in Fig. 8 and Fig. 9 there is growth in the magnitude of this force as well as its ratio to the main cutting force with a decrease of DOC. From these results can therefore be argued that if the goal is to maximize the stability of the process, then DOC higher than nose radius should be used. A decrease in DOC significantly lowers the main cutting force, however, when minimizing the deformation of the workpiece in the X axis is also required then inserts with a nose radius lower than DOC should be used.

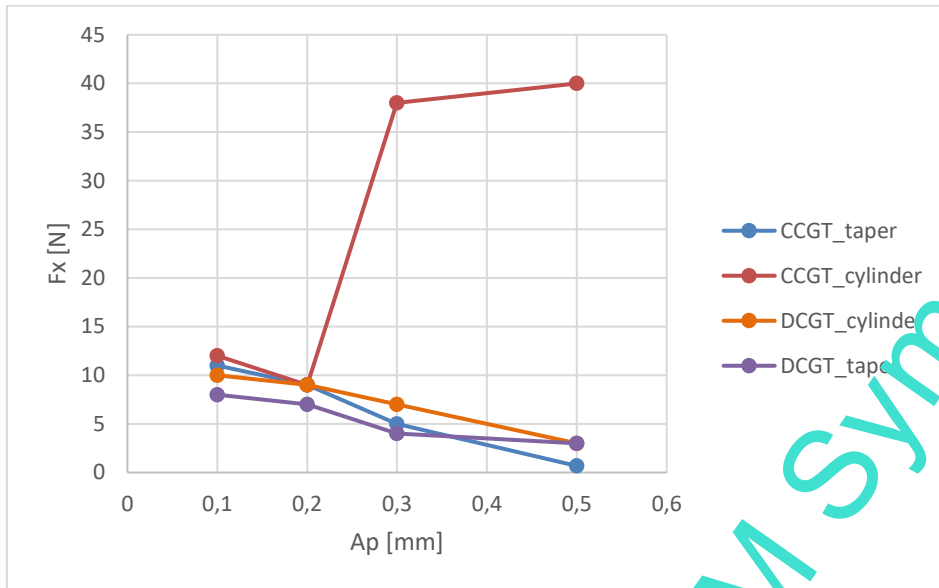

Fig. 8. Dependence between DOC and cutting force in the X axis direction

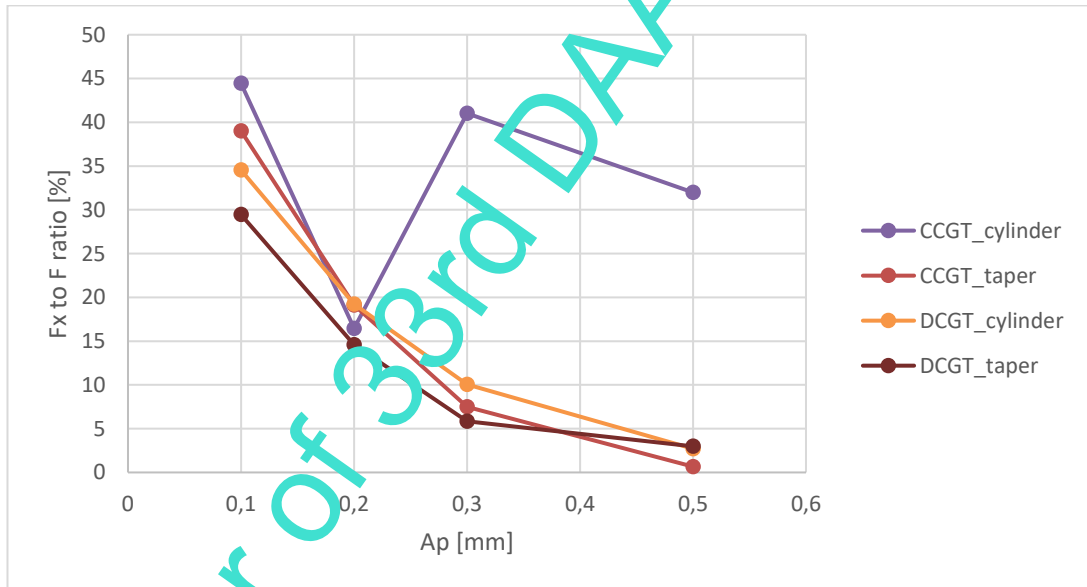

Fig. 9. The influence of DOC on the ratio of Fx and main cutting force

Working Paper Of 33rd DAAAM Symposium

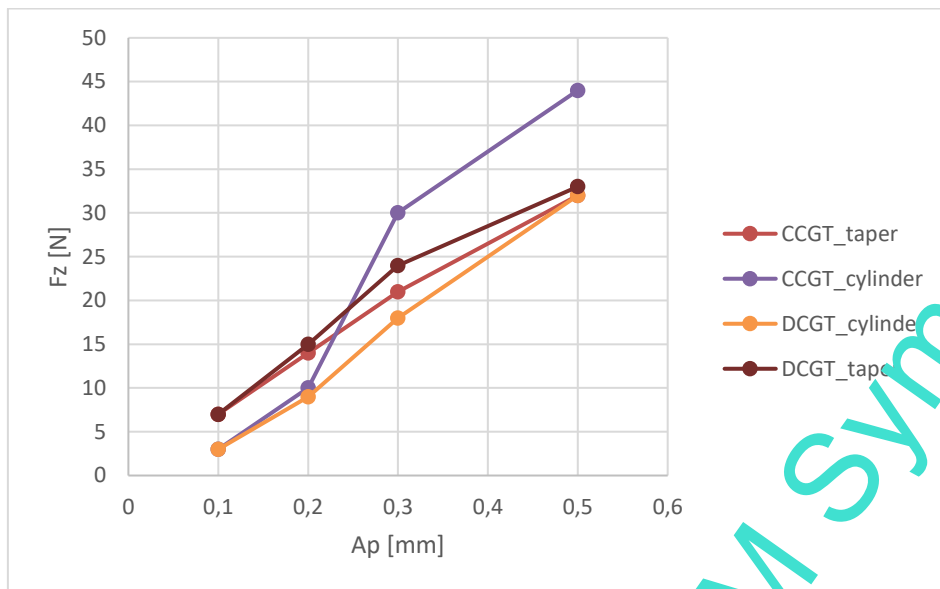

Fig. 10. Dependence between DOC and force in the Z-axis direction

5. Conclusion

This study aims to investigate the influence of several variables on the cutting forces generated during the turning of titanium alloy. The focus was given to the F_x component of the main cutting force which plays a role in the stability of the turning process and the final dimensional and geometrical accuracy of the parts. The magnitude of the F_x component is generally significantly lower than the F_y (F_c) component, however, under certain conditions, F_x can become substantial. Force components coincident with the coordinate system of the machine tool (F_x , F_y , F_z) were used in the study together with the more common F_p , F_c , F_f , because F_x , F_y , F_z are not dependent on the geometry of a workpiece. The following conclusions can be drawn from the results:

- Machining tapered geometry (30° included angle), causes a shift in the direction of F_p and F_f forces, reducing the F_x force and increasing the F_z force.
- The ECEA can play a significant role in the F_x force component, although there seems to be a value above which its influence becomes less significant. This can be observed by comparing both inserts and machined geometries. When cylindrical geometry is machined, the CCGT (effective ECEA is 5°) insert shows on average a 17 % higher F_x force than the DCGT (effective ECEA is 32°) insert. In the case of tapered geometry, the difference in F_x force is on average only 4 % and the effective ECEA is 20° for the CCGT and 47° for the DCGT insert.
- With a decrease in DOC, the exponential growth of the F_x to F ratio can be observed. Lowering of DOC leads to increased contribution of F_x at the expense of F_z , therefore, possible increase in radial deformation of a workpiece.

It can be concluded that a reduction in the F_x force can be achieved by either an increase in DOC or a reduction of nose radius. Furthermore, if an ECEA is under a certain value its increase can also play a significant role. Finally, an increase in effective SCEA will also reduce F_x force.

The force measurements that were influenced by the difference in mechanical properties in some sections of the workpiece will be repeated in further research. Additionally, tools with different nose radii will be investigated in the future as well as higher values of DOC. Lastly, other workpiece materials with significantly dissimilar mechanical properties will be tested to explore the effect of this variable.

6. Acknowledgements

The article contribution has been prepared under project SGS-2022-007 - Research and Development for Innovation in Engineering Technology - Machining Technology IV.

5. References

--

- [1] D. Singha, A. Mandal, and S. Kar, "Simulation, analysis and comparison of cutting parameter during turning of Ti-6Al-4V alloy with assorted industrial coated carbide," *Materials Today: Proceedings*, vol. 62, pp. 6136–6142, 2022, doi: 10.1016/j.matpr.2022.05.025.
- [2] G. Hou, A. Li, X. Song, H. Sun, and J. Zhao, "Effect of cutting parameters on surface quality in multi-step turning of Ti-6Al-4V titanium alloy," *Int J Adv Manuf Technol*, vol. 98, no. 5–8, pp. 1355–1365, Sep. 2018, doi: 10.1007/s00170-018-2317-y.
- [3] B. Buldum, U. Eşme, M. Kemal Külekci, A. Şik, and Y. Kazançoğlu, "Use of Grey-Taguchi Method for the Optimization of Oblique Turning Process of AZ91D Magnesium Alloy," *Materials Testing*, vol. 54, no. 11–12, pp. 779–785, Nov. 2012, doi: 10.3139/120.110392.
- [4] E. Netolická, "Parametry řezného procesu," Czech technical university in Prague, Prague, 2016.
- [5] R. Nur, N. M. Yusof, I. Sudin, F. M. Nor, and D. Kurniawan, "Determination of Energy Consumption during Turning of Hardened Stainless Steel Using Resultant Cutting Force," *Metals*, vol. 11, no. 4, p. 565, Mar. 2021, doi: 10.3390/met11040565.
- [6] S. Yaldız and F. Ünsaçar, "A dynamometer design for measurement the cutting forces on turning," *Measurement*, vol. 39, no. 1, pp. 80–89, Jan. 2006, doi: 10.1016/j.measurement.2005.07.008.
- [7] R. Čep and J. Petrů, "Experimentální metody v obrábění," p. 146.
- [8] H. Saglam, S. Yaldiz, and F. Unsacar, "The effect of tool geometry and cutting speed on main cutting force and tool tip temperature," *Materials & Design*, vol. 28, no. 1, pp. 101–111, Jan. 2007, doi: 10.1016/j.matdes.2005.05.015.
- [9] D.-A. Coroni and S.-M. Croitoru, "Prediction of Cutting Forces at 2D Titanium Machining," *Annals of DAAAM for 2013 & Proceedings of the 24th International DAAAM Symposium*, Published by DAAAM International, Vienna, 2013, doi: 10.1016/j.proeng.2014.02.206.
- [10] Ovako, "C45." <https://steelnavigator.ovako.com/steel-grades/c45/> (accessed Apr. 20, 2022).
- [11] Aerospace specification metals Inc., "Titanium Ti-6Al-4V (Grade 5), Annealed." <https://asm.matweb.com/search/SpecificMaterial.asp?bassnum=MTP6-1> (accessed Apr. 20, 2022).
- [12] A. Pramanik, "Problems and solutions in machining of titanium alloy," *Int J Adv Manuf Technol*, vol. 70, no. 5–8, pp. 919–928, Feb. 2014, doi: 10.1007/s00170-013-5326-x.
- [13] Aerospace specification metals Inc., "Aluminum 7075-T6 (7075-T651)." <https://asm.matweb.com/search/SpecificMaterial.asp?bassnum=na7075t6> (accessed Jun. 30, 2022).